

MaxMotion

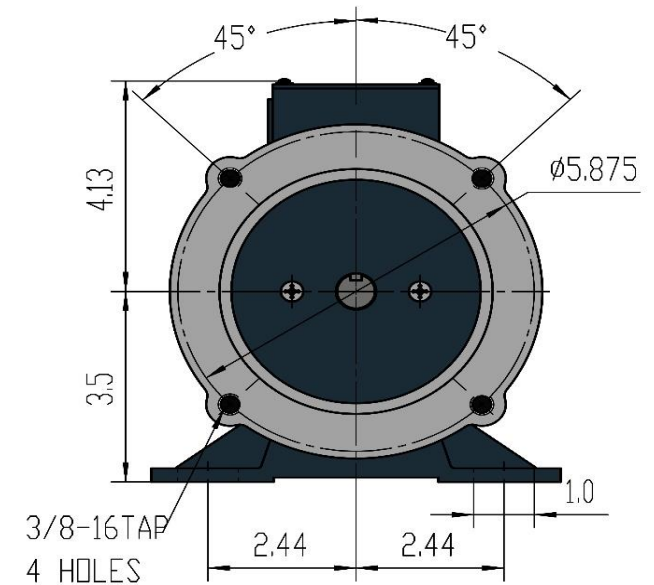
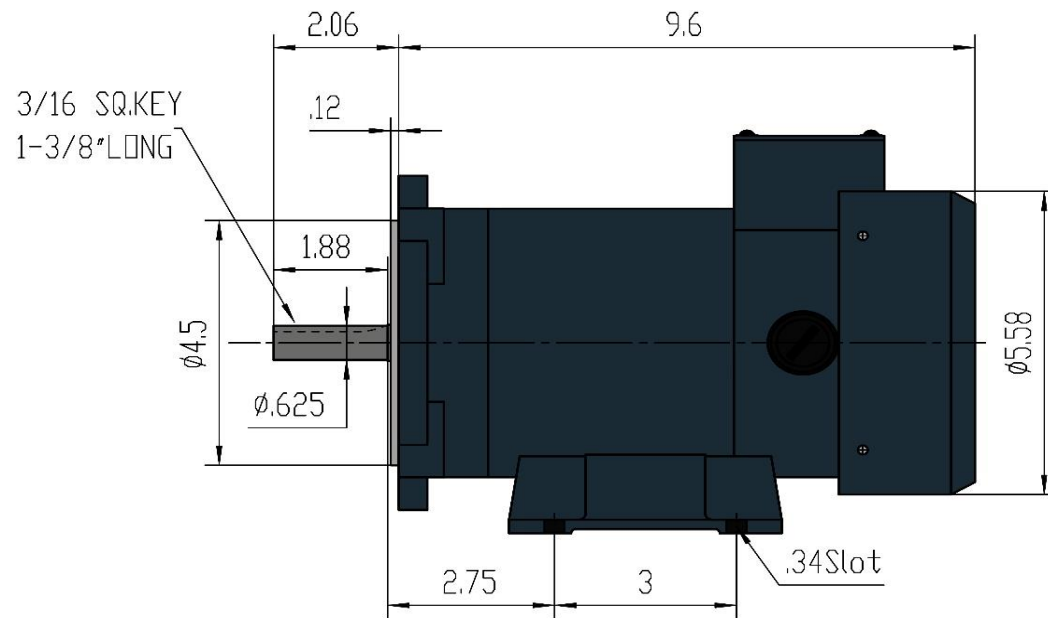

Customer is responsible in determining that MaxMotion product will fit/performance suitably in the intended application

Version: 1NIN

Revised: April 2020

HP	RPM	Voltage	Amps	Const.	Frame	Insul.	Torque	P. Code	Wgt lbs	Rated
0,25	1750	90Vdc	4,1	TEFC	56C	Class H	9 in/lbs	K (SCR)	21	IP45

MM2590FC